

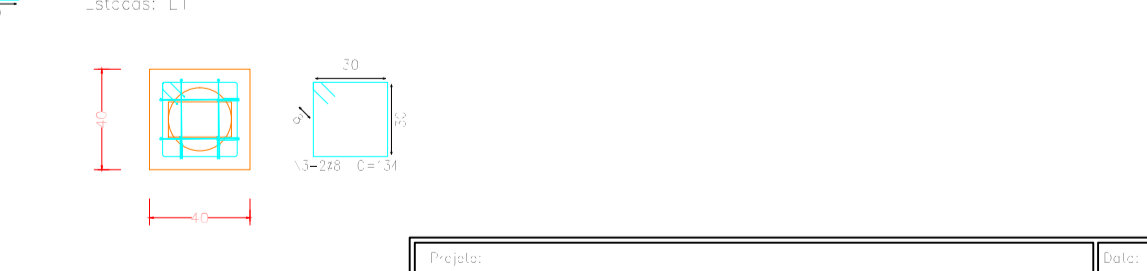

Comprimos
colunas de concreto
armado com aço
CA-500

Item	Descrição	Quantidade	Unidade
01	CA-500 12x12	10	m
02	CA-500 10x10	10	m
03	CA-500 8x8	10	m
04	CA-500 6x6	10	m
05	CA-500 4x4	10	m

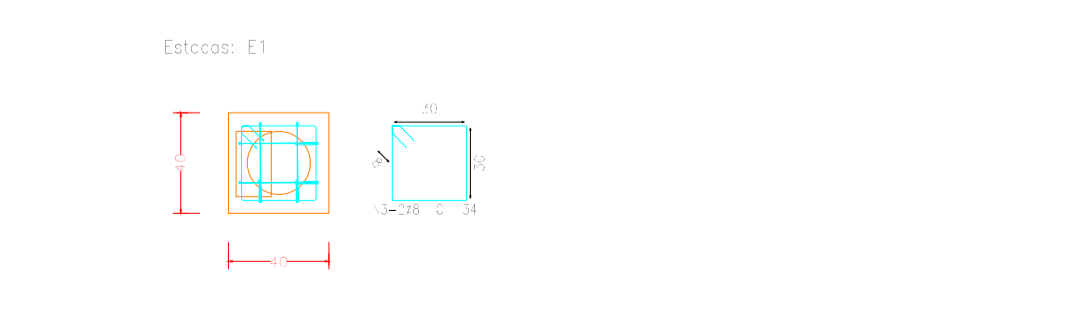
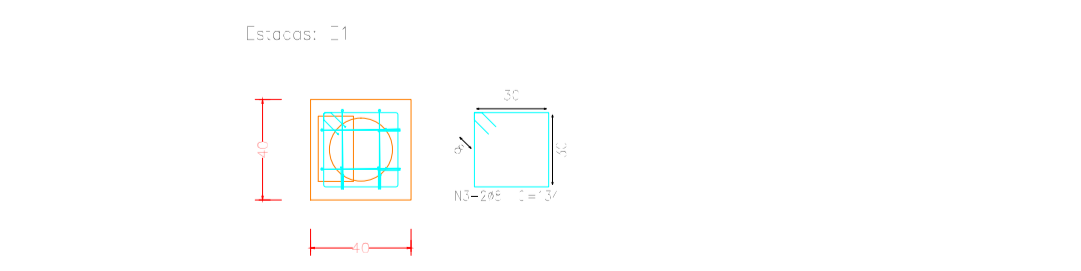
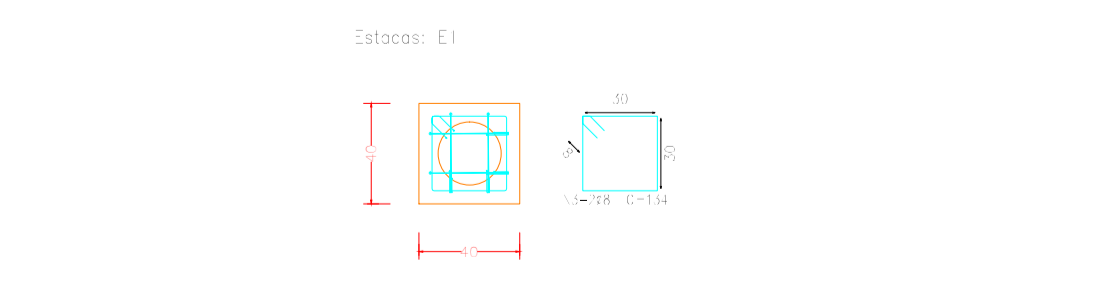
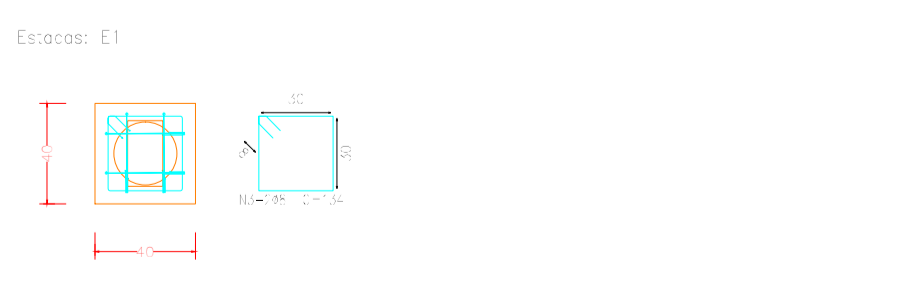
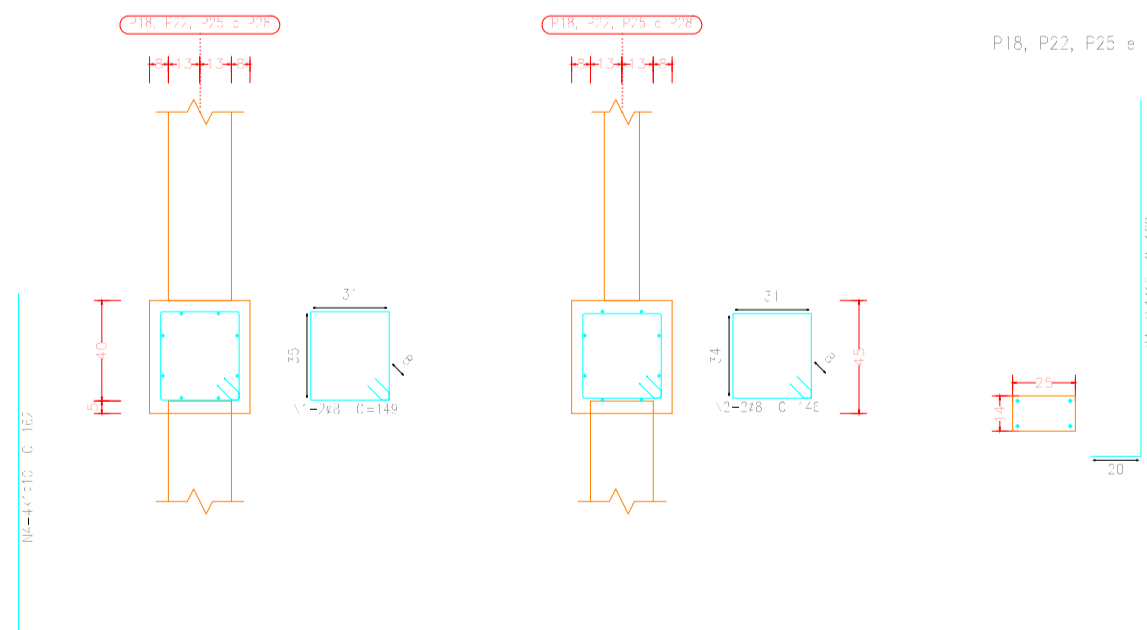
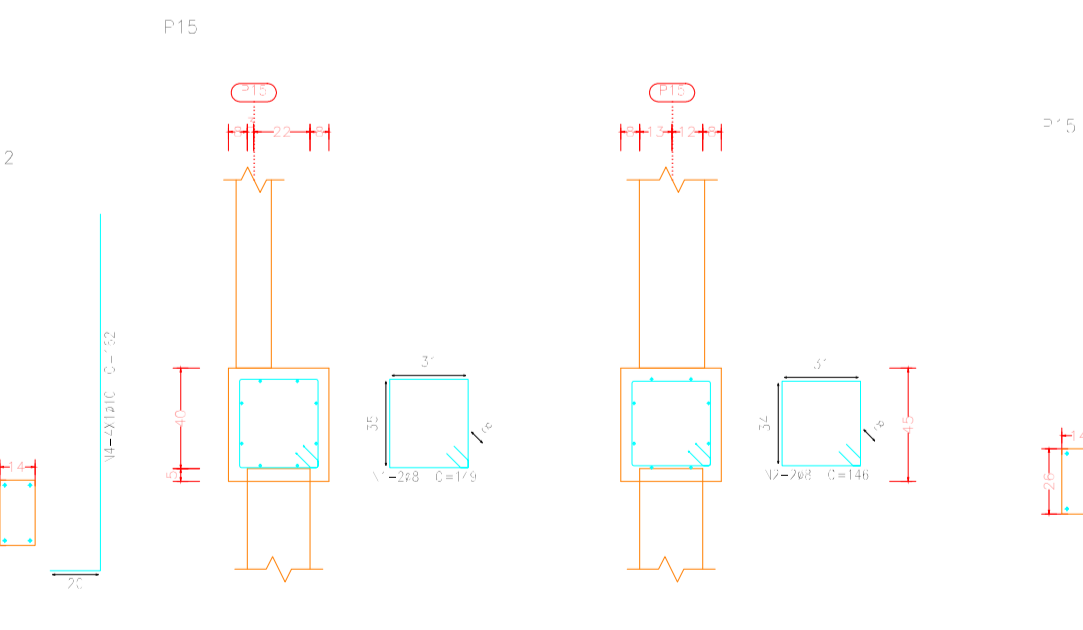
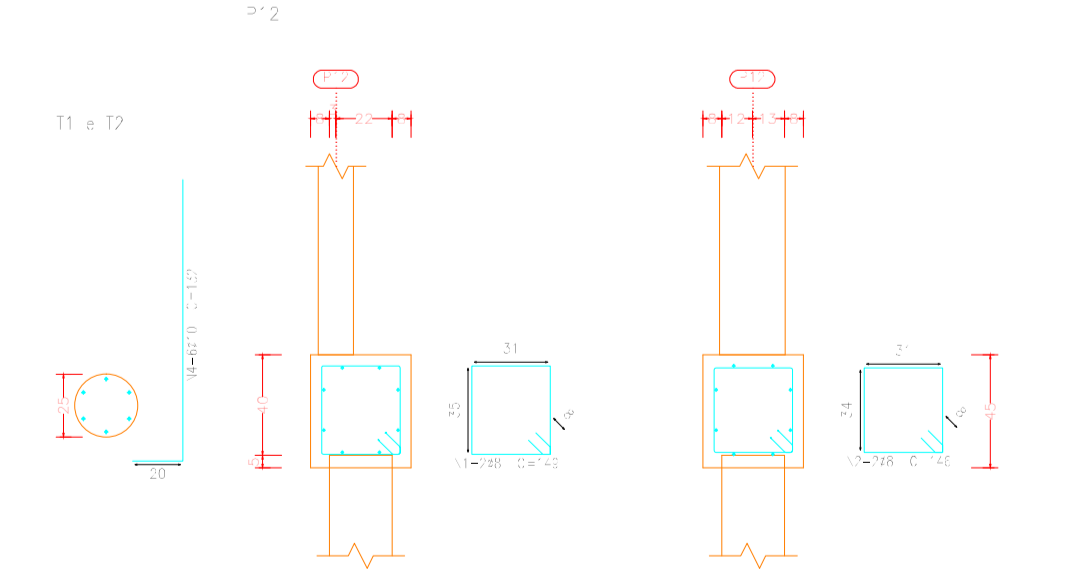
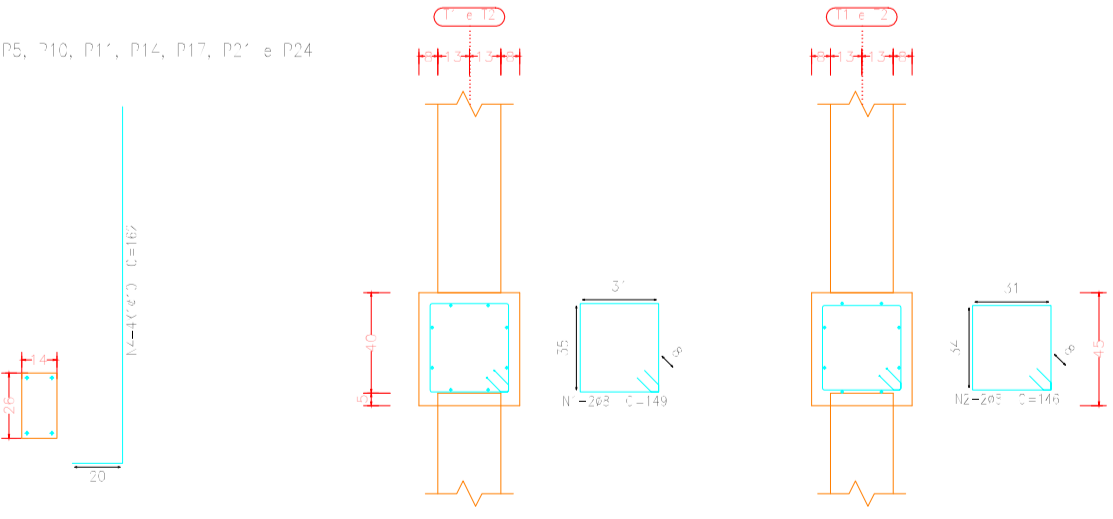
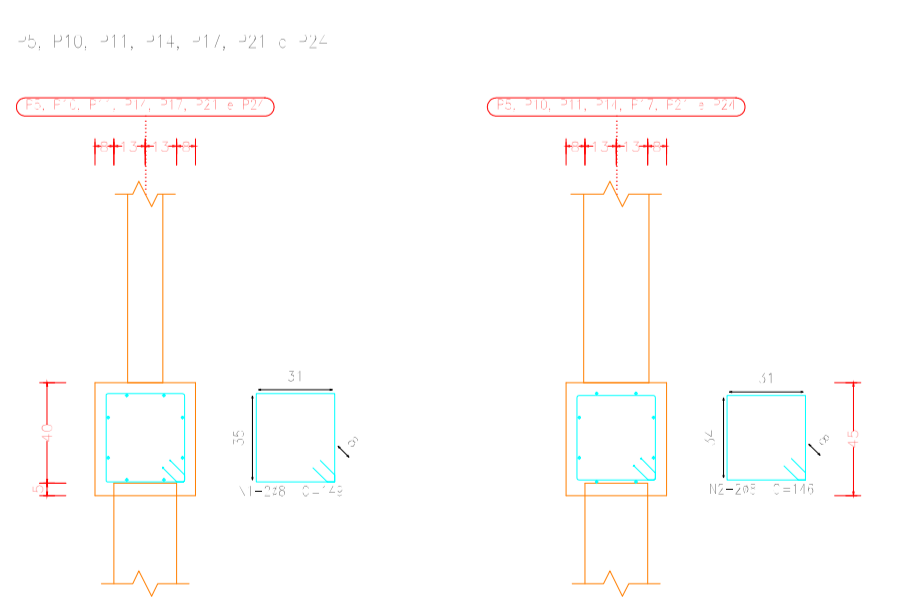
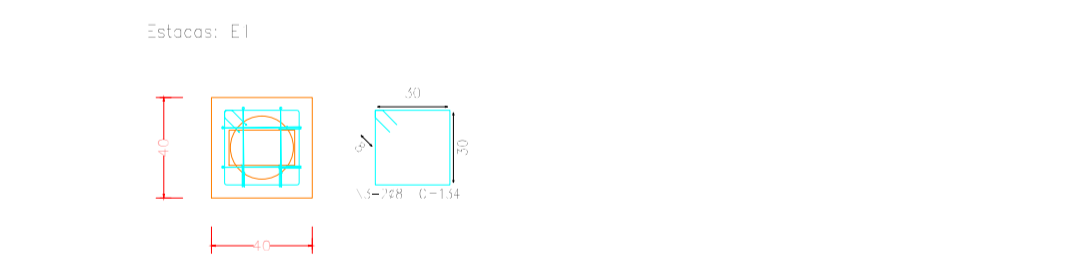
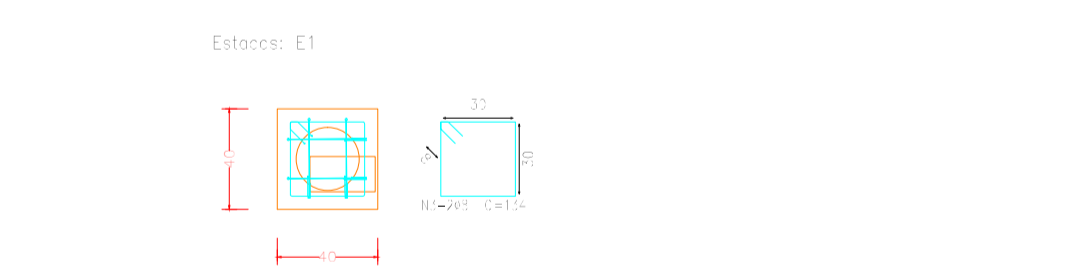
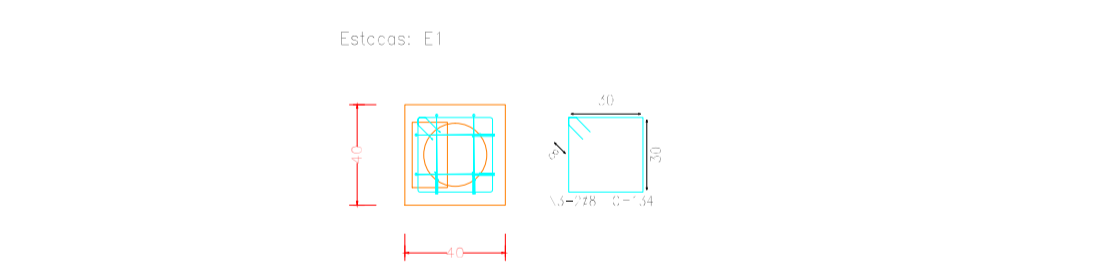
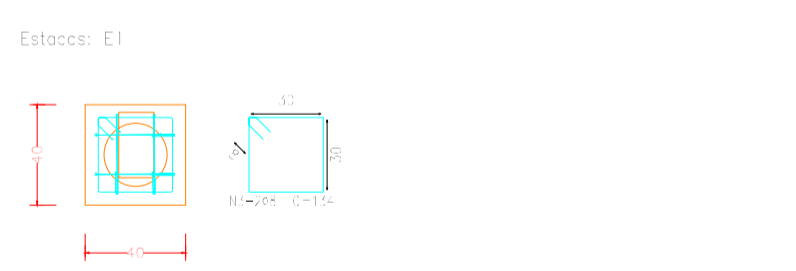
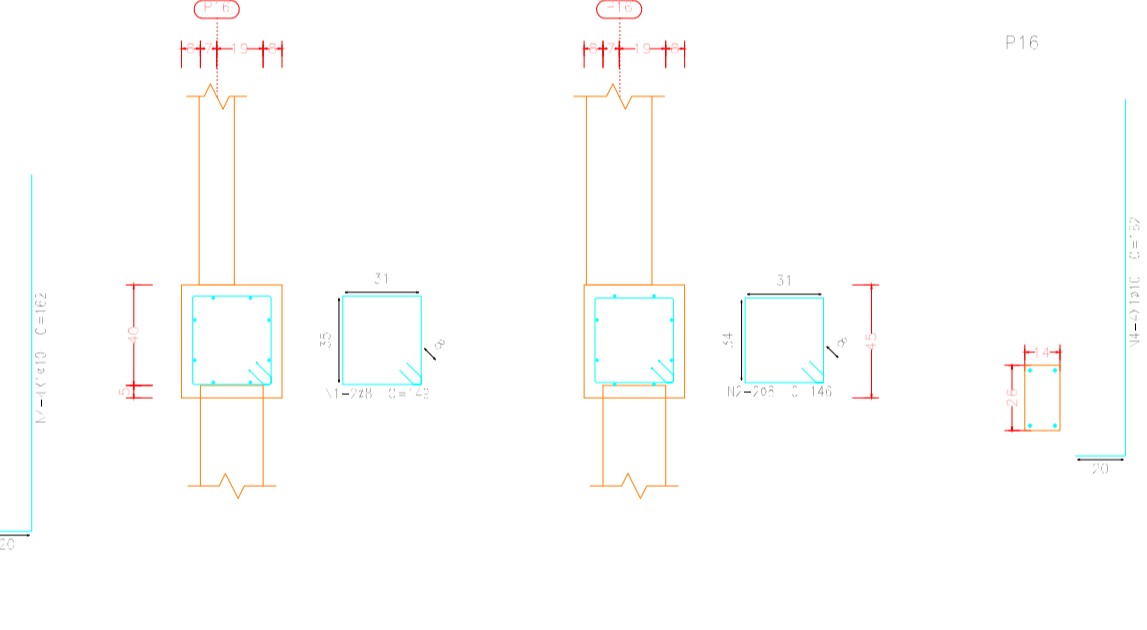
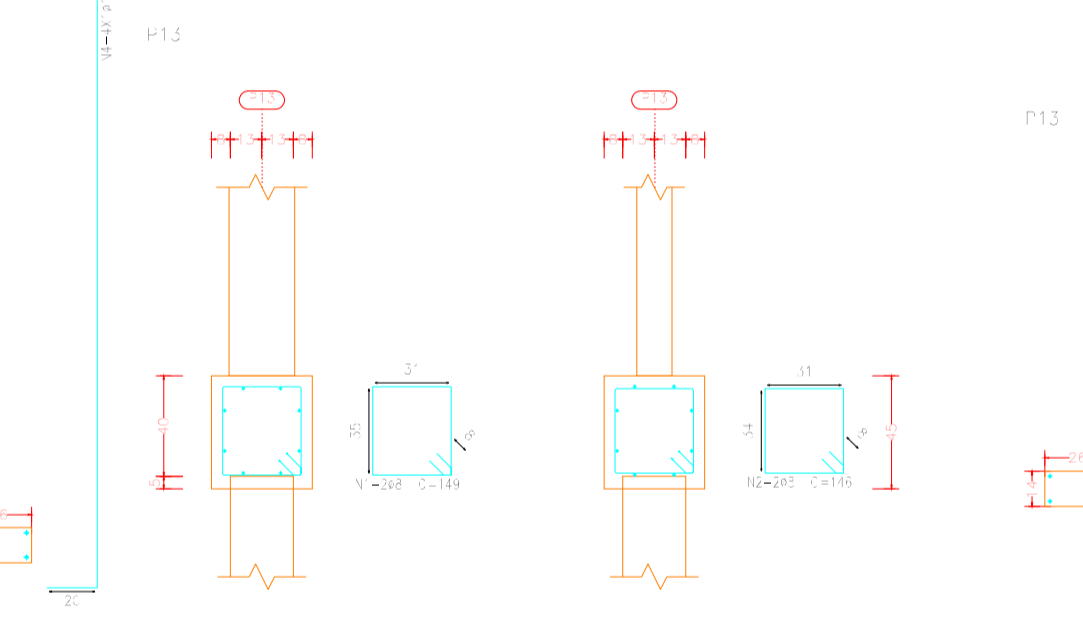
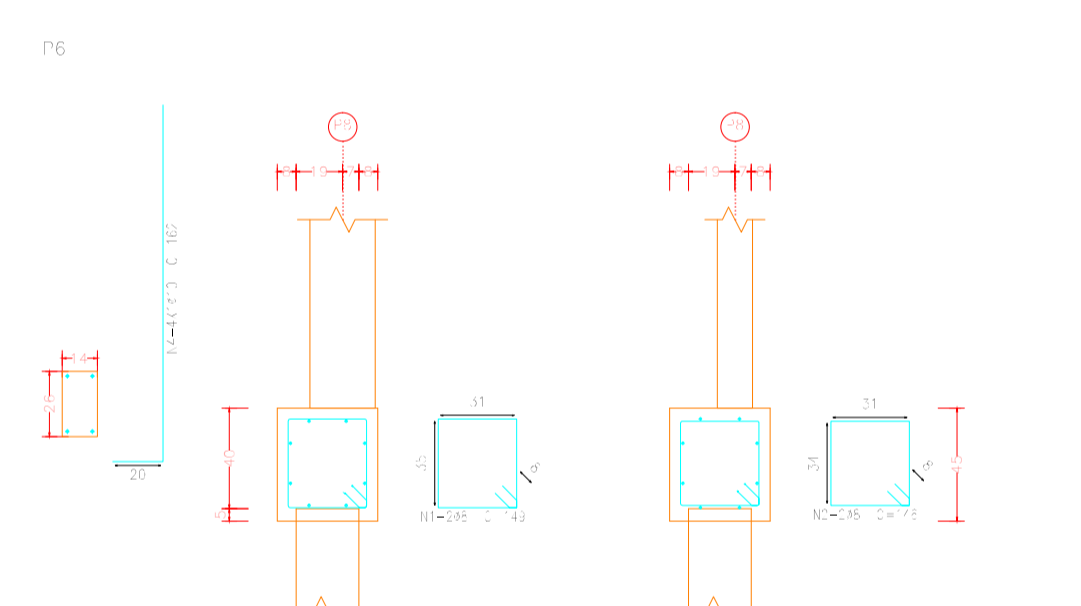
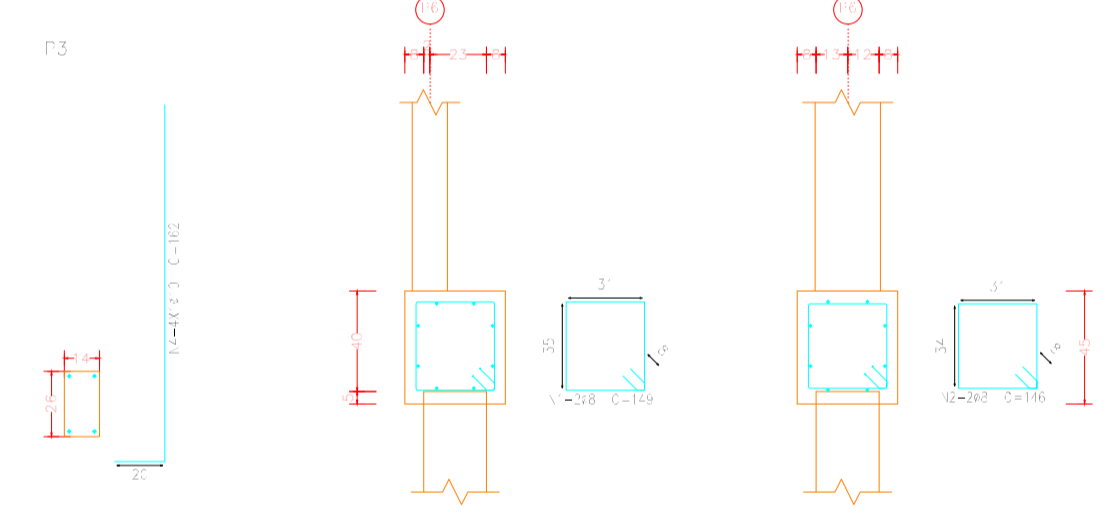
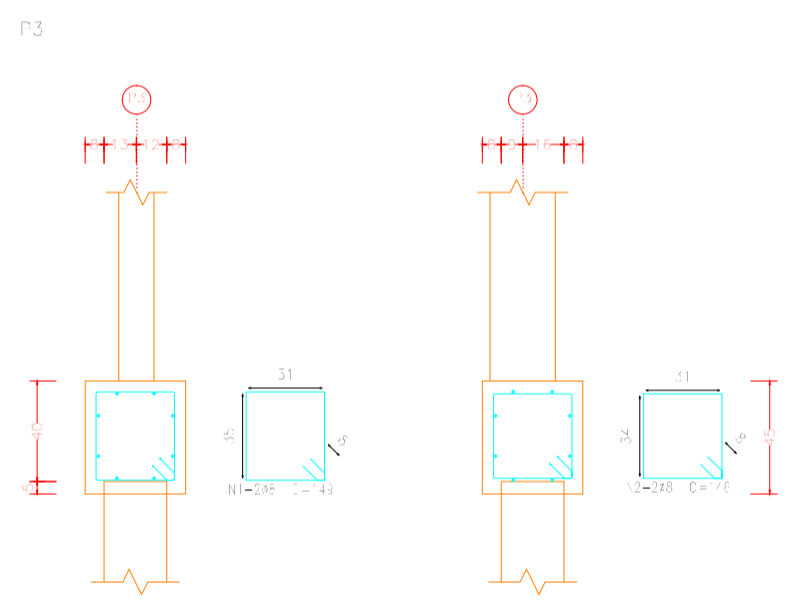
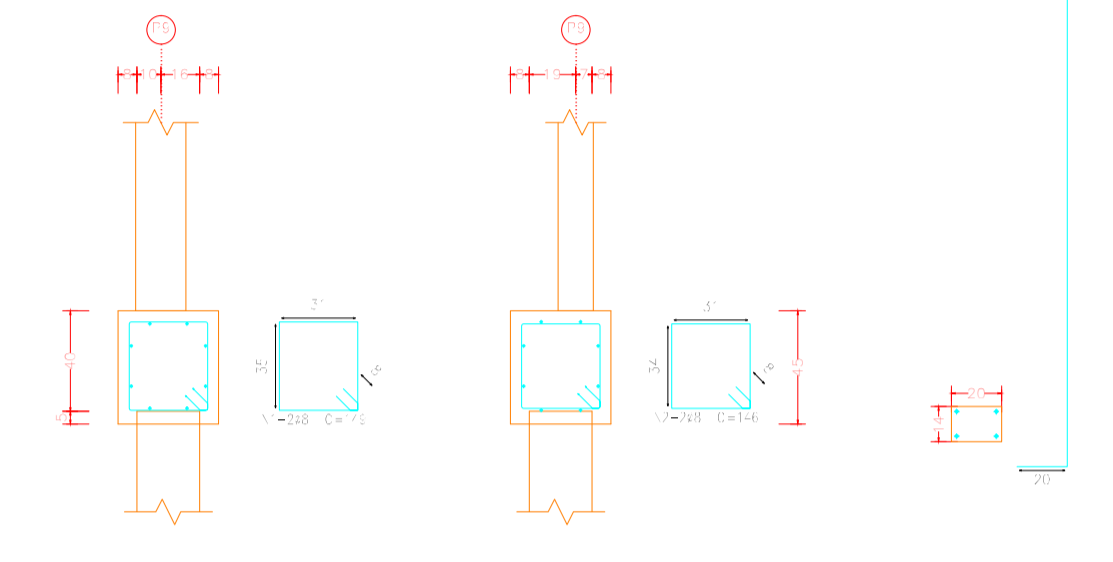
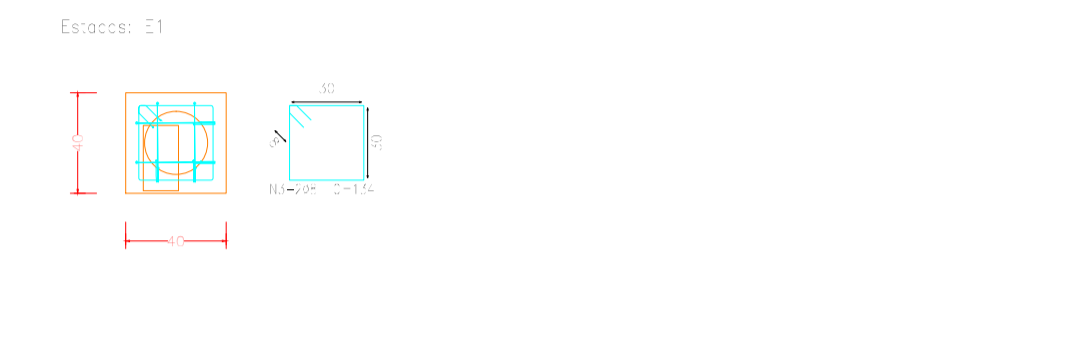
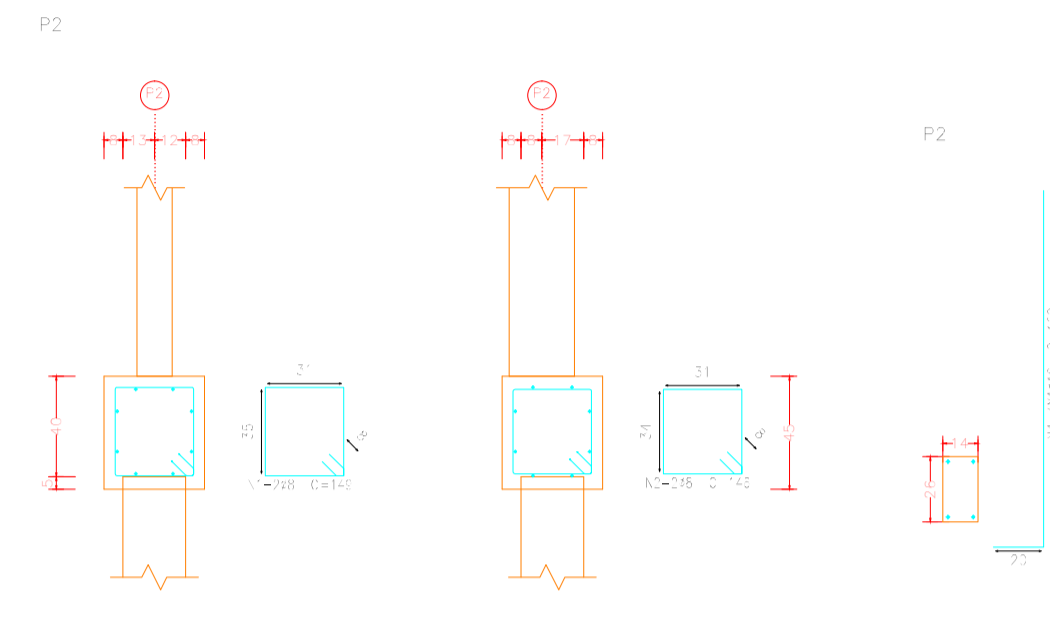
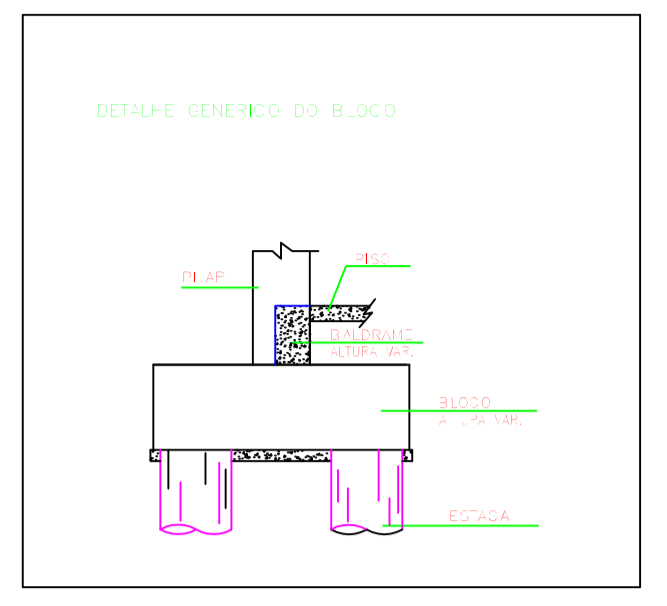
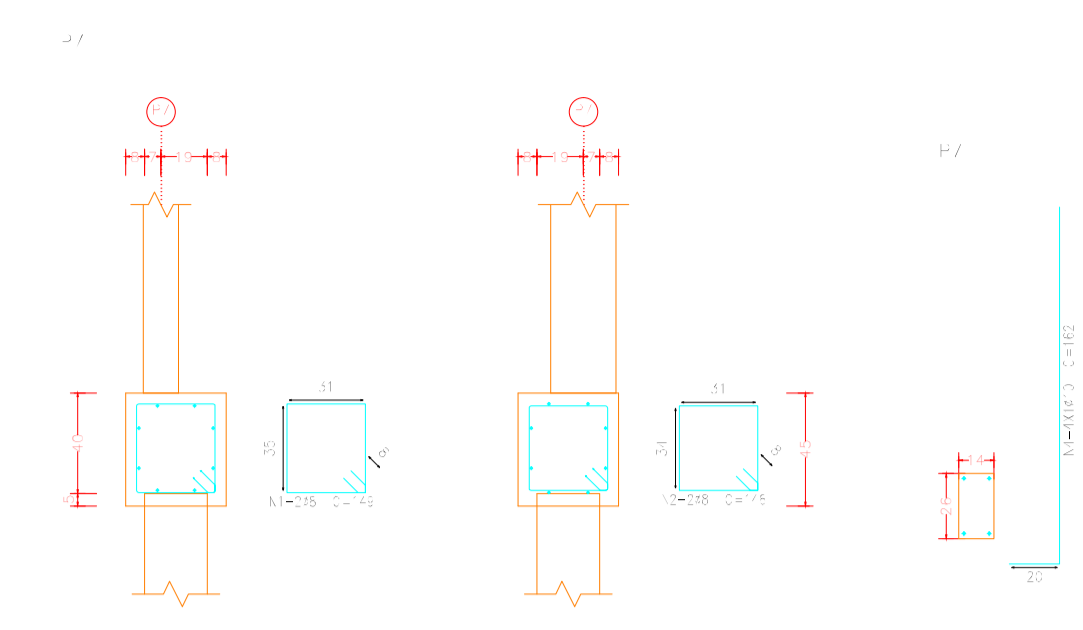
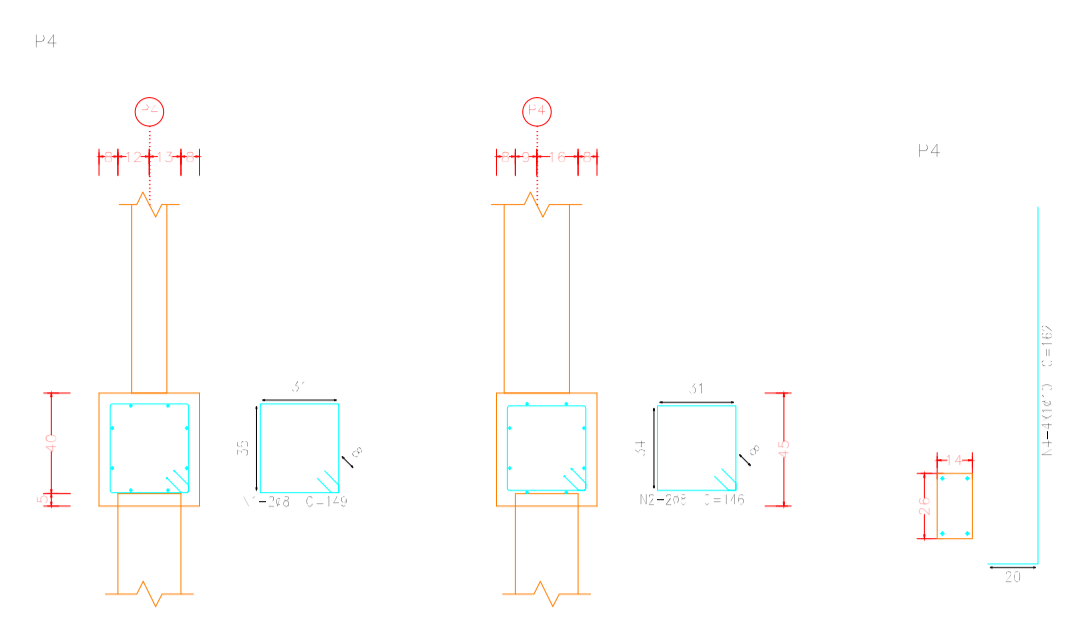

Projeto:	08/2023	Revizão:	01/2023
Cliente:	[Redacted]		
Escritório:	[Redacted]		
Arquiteto:	[Redacted]		
Projeto:	[Redacted]		
Arquiteta:	[Redacted]		
Arquiteta:	[Redacted]		